

# Sundance® Spas



Maxxus

## Installation & Owner's Manual

# ADDENDUM

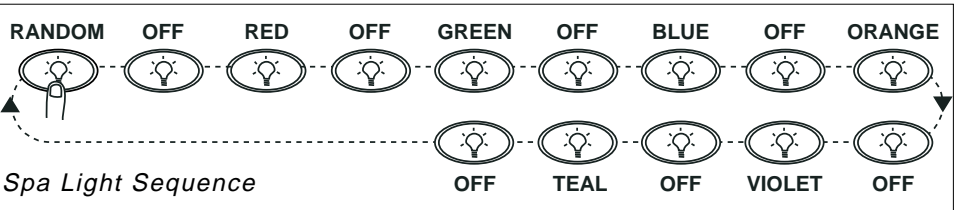
## Sundance Maxxus Owner's Manual #6530-373, Revision-B

The following changes apply to your new Sundance Maxxus Owner's Manual. Please refer to these instructions for proper operation of the standard SunGlow™ multi-colored light and optional SunSound™ audio system (when applicable).

---

### Standard SunGlow™ Spa Light

The 2002 Maxxus now includes the popular SunGlow™ multi-colored light kit as standard equipment! This new light offers 6 constant color variations and a unique random mode for enhanced spa enjoyment. Press the **LIGHT** sensor pad once to turn the spa light on in "Random" mode, then repeatedly press the sensor pad to turn the light off or to select one of 6 constant colors illustrated below.



You must press the **LIGHT** sensor pad within 5 seconds between each "off" or "color" step in the light sequence to prevent it from resetting. Pressing the sensor pad after 5 seconds restarts the sequence at "Random" mode. This mode automatically changes the light color every 8 to 20 seconds. *Note: Any time the spa light is manually turned on, it will automatically turn off after approximately 1 hour. If you desire more light at this time, simply turn the light back on.*

---

### 8.10 Optional SunSound™ Audio System

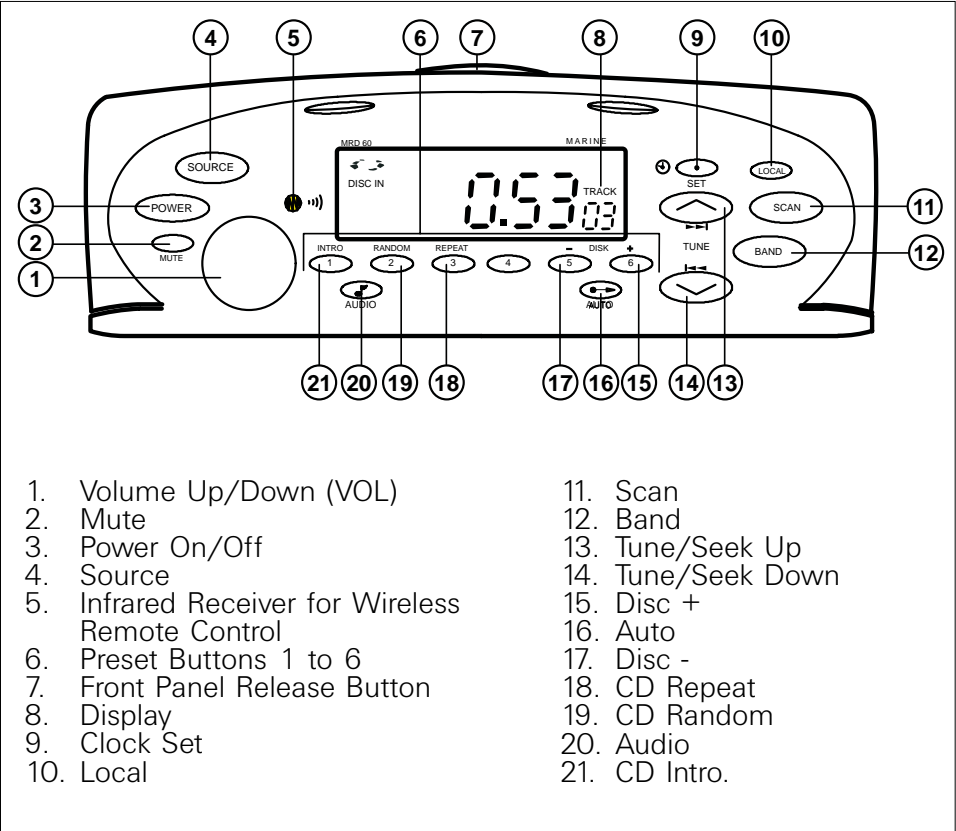
Sundance models with the optional audio system offer enhanced spa enjoyment by offering an integrated state-of-the-art audio system. These models include a high-quality AM/FM/CD splash-resistant marine stereo receiver, two high-quality marine speakers, and an integrated subwoofer for long-life and an excellent sound quality. Two speakers located on spa corners (Figure-F, page 16) are designed for manual exposure and retraction. To expose each speaker for audio playback, simply press down on each enclosure to unlatch its "pop-up" mechanism, then release. To retract each speaker before covering spa, gently press



downward on each enclosure until you feel a slight “click”, then release.

**CAUTION:** Never step or sit on a speaker enclosure! This type of misuse will damage the speaker enclosure latching and track mechanism. Always retract speakers prior to covering spa.

### Optional SunSound™ Stereo Receiver Features



### Optional SunSound™ Stereo Receiver General Controls

#### A. Power On and Off

Make spa power is turned on, then press power button (3) once to turn on. Press a second time to turn off.

#### B. Adjusting Volume

Rotate volume knob (1) to increase or decrease volume. Current volume setting is briefly indicated on the display (0 to 31).

#### C. Mute

Press mute button (2) once to mute audio output (“Mute” flashes on display). To restore audio output, press mute button a second time, or rotate volume knob.

#### **D. Program Selection**

Press source button (4) to cycle through available program sources as follows: Tuner - CD - Tuner. If a source is unavailable (e.g. no CD inserted), that source will not appear on the display.

#### **E. Adjusting Bass Level**

Press audio button (20) until display reads "BAS." Rotate volume knob to desired setting. A display of "C O" indicates center, -2 to -12 indicates bass cut, and +2 to +12 indicates bass boost. *Note: unit returns to volume mode if volume control is not rotated for 3 seconds.*

#### **F. Adjusting Treble Level**

Press audio button (20) until display reads "TRE." Rotate volume knob to desired setting. A display of "C O" indicates center, -2 to -12 indicates treble cut, +2 to +12 indicates treble boost. *Note: unit returns to volume mode if volume control is not rotated for 3 seconds.*

#### **G. Adjusting Balance**

Press the audio button (20) until display indicates "BAL." Rotate volume knob to desired setting. A display of "C O" indicates center, L1 to 15 indicates left balance, R1 to 15 indicates right balance. *Note: unit returns to volume mode if volume control is not rotated for 3 seconds.*

### **Optional SunSound™ Stereo Receiver Radio Operation**

#### **A. Adjust Fader**

Press audio button (20) until display reads "FAD." Rotate volume knob to desired setting. A display of "C O" indicates center, "R" 1 to 15 indicate rear fade, "F" 1 to 15 indicates front fade. *Note: unit returns to volume mode if volume control is not rotated for 3 seconds.*

#### **B. Display Clock**

Press set button (9) to toggle display between clock and radio modes. When clock mode is selected, the current time displays whenever the unit is left undisturbed.

#### **C. Set Clock**

Press and hold set button (9) for 2 seconds until first time digit flashes on display. Use tune/seek-up button (13) or tune/seen-down button (14) to set hour, noting AM/PM indicator at left. Briefly press set button a second time to select minutes display. Press set button a third time to complete procedure. Unit remains in clock mode and displays time after 3 seconds. *Note: When power to spa is shut off for any reason, the*

*clock will be reset to 12:00 AM.*

#### **D. Open/Close Front Panel**

Place thumb on front panel release button (7) with forefinger below front overhang. Press firmly on release button, then flip panel open by pulling outward at top edge. To close panel, flip panel up and press firmly until you hear an audible click. Keep the front panel closed at all times to prevent water intrusion, except when changing discs. ***CAUTION: never insert wet discs into unit or CD player will be damaged!***

#### **E. Radio Operation**

Press source button (4) to select radio mode. Station frequency is indicated on display.

- To Select Band: press band button (12) to toggle through radio modes as follows: FM1 - FM2 - FM3 - AM1 - AM2 - FM1. Each radio band stores up to 6 independent presents, for a total of 18 FM and 12 AM presents.
- To Program Presets: tune in desired radio station, then press and hold desired preset button for at least 2 seconds. "PX", where X=preset number, appears at bottom right of the display. *Note: When power to spa is shut off for any reason, all station presets are reset.*

#### **F. Automatically Setting Station Presets**

To automatically set station presets to their next higher stations, press the preset button (1 to 6) from which to start programming, then press and hold the auto button (16) for at least 2 seconds. The current station preset and additional preset memories up to P6 will be reprogrammed with their next higher tunable stations. When the auto preset cycle is complete, the unit will remain in preset scan mode and continue scanning for presets until the auto button (16) is pressed. To select only the strongest stations, press the local button (10). All 18 FM and 12 AM presets can be set sequentially by selecting the next band and continuing the operation during auto programming.

#### **G. Seek / Manual Tune**

Press tune/seek-up button (13) once to automatically tune the next higher station. Press tune/seek-down button (14) once to automatically tune the next lower station. To manually tune to a specific station frequency, press and hold either tune/seek button for at least 2 seconds. Holding either button down will increase or decrease the displayed frequency manually. When the desired frequency is reached, release the button. The unit remains in manual tune mode for 3 seconds after either button is released so you can fine tune the station frequency with additional button presses. *Note: After 3 seconds, seek mode is re-enabled.*

## H. Scan Functions

Select any AM or FM band and press scan button (11) to listen to a few seconds of each radio station. The display will flash and the radio will automatically scan to the next higher station, play that station for a few seconds, then scan to the next higher station. To stop scanning and continue listening to the current station, press scan button a second time. *Note: the radio remains in scan mode until the scan button is pressed a second time or one of the tune buttons is pressed.*

## I. Preset Scan Function

Press the auto button (16) once to enter scan mode. The next higher preset station will be selected and be played for 3 seconds while the preset number on the display flashes. If you wish to remain on this station, press the auto button (16) a second time. *Note: preset scanning continues unless you press the auto button (16) or either preset button (P1-P6) to cancel.*

## J. Local/Distance Function

Press the local button (10) to toggle between local and distant station mode. When "LOCAL" is displayed, only the strongest stations will be selected during seek or scan. *Note: in the default mode (no LOCAL display), all usable stations will be selected during seek or scan.*

## K. Changing Tuner Frequency from US to Europe

Your unit is factory set to US tuning frequency steps. To switch to Europe tuning steps, use the switch on the bottom of the unit. With the unit disconnected from the power source, use a screwdriver to slide the switch to the desired position. ***Note: power must be removed from the radio, or the reset switch must be pressed before the new frequency mode is activated.***

## Optional SunSound™ Stereo Receiver CD Player Operation

### A. Insert, Play, and Eject a CD

Open the front panel and insert a CD into the slot with the CD label facing up. The CD will be drawn inside by the motorized mechanism. Close the front panel. The "DISC IN" symbol on the display indicates that a CD is in the drive.

- To play CD: press the source button (4) to change to CD mode. The CD will play. The display shows the current track and play time, and will animate a 3-D rotating disc while the CD is playing. *Note: if CD play time is not shown, press clock set button (9) once.*

- To remove CD: open the front panel and press the CD eject button located under the front panel. Remove CD from drive and close front panel. ***CAUTION: listen for an audible click to ensure the front panel is closed to prevent water intrusion that could damage your unit.***

## **B. Changing CD Tracks and Music Seek**

To advance to the next track, press the tune/seek-up button (13) once and the track counter will increase one track. When the final track is reached on the CD, play will resume on track #1.

- To fast forward through tracks: press and hold the tune/seek-up button (13) until the track counter displays the desired track, then release the button.
- To return to the beginning of the current track: press the tune/seek-down button (14). Pressing it a second time within 1 second will skip back to the previous track.
- To rewind the current track: press and hold the tune/seek-down button (14). The track will quickly rewind until you release the button.

## **C. Intro Scan, Random, Repeat**

- Intro Scan Mode: press intro button (21) to enter intro scan mode. The left side of the display reads "SCN" and the first 10 seconds of each CD track will play continuously until you press the intro button a second time, or press either tune/seek-up button (13) or tune/seek-down button (14).
- Random Mode: press the random button (19) to play the CD tracks in random order. The left side of the display reads "RDM" when random mode is enabled.
- Repeat Mode: press the repeat button (18) to repeat the current CD track continuously. The left side of the display reads "RPT" when repeat mode is enabled.

## **Optional SunSound™ Stereo Receiver Troubleshooting**

### **A. Unit will not turn-on**

Make sure spa power is turned on, then check both harness fuses on back of unit making sure they are the proper ratings:

- Yellow memory B+ line (1A fuse); Red ACC line (10A fuse).
- With spa power off, use a thin rod to press the reset button located under the front panel.

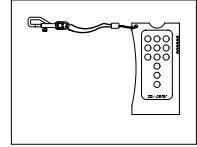
### **B. Fogged CDs and Lens**

This condition may occur when it's cold. Wipe fogged CDs with a

soft cloth. Fogged optical components inside the unit will return to normal operation after an hour in a heated environment.

**Wireless Remote Control**

To ensure maximum life of the supplied wireless stereo remote, we recommend never submerging it in water or leaving it under the spa cover! Prolonged exposure to moisture will damage the remote!



**Wireless Remote Battery Replacement Procedure**

Remove remote from rubber housing, then remove protective adhesive seal from battery door. Depress hook with thumbnail and pull outward on battery door. Replace depleted battery with fresh battery, be sure to note polarity. Install battery door. Replace adhesive seal material, making sure to cover the entire cover gap (additional seal material included, if required). Replace remote firmly into rubber housing.

Wireless Remote Control Specifications

Usable range. . . . . 15 ft. (5m)  
Battery . . . . . Coin Type, CR2025 or equivalent

**Stereo Receiver Specifications**

Tuner

FM usable sensitivity. . . . . 10 dBf  
FM 50 dB quieting sensitivity. . . . . 15 dBf  
FM alternate channel selectivity. . . . . 90 dB  
FM stereo separation @ 1kHz. . . . . 60 dBf  
AM usable sensitivity . . . . . 30 uV

CD Player

Sampling frequency (8X oversampling). . . . . 44.1 kHz  
Channel separation @ 1 kHz . . . . . 80 db

Signal-to-noise ratio . . . . . 90 dBA  
Frequency-to-noise response @ ±1 dB . . . . . 20-20 kHz

Audio

Maximum power output (45 watts x 4 channel) . . . . . 180 W  
Continuous power, 20-20 kHz, 4 ohms, 1% THD. . . . . 18 x 4  
Bass boost/cut . . . . . 10/100±dB/Hz  
Treble boost/cut . . . . . 10/10+/-dB/kHz

General

Nominal power supply . . . . . 14.4 VDC  
Allowable power supply . . . . . 10.8-15.6 VDC  
Current consumption. . . . . <10 Amp  
Speaker impedance . . . . . 4-8 Ohms



## 13.0 Troubleshooting - Display Messages

### MESSAGE

**FLO2**

### MEANING

CLOSED OR SHORTED FLOW SWITCH ON SYSTEM STARTUP (system disabled) Flow switch is non-functional. This must be repaired only by a dealer or qualified service organization.

**ICE  
ICE2**

### FREEZE PROTECTION

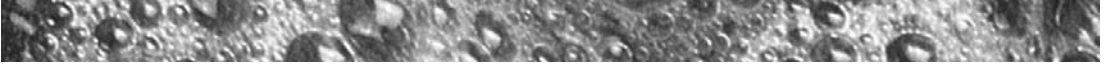
A potential freeze condition has been detected. No action is required. Pump(s) operate until the hot tub is out of danger. Note: This error commonly occurs when the hot tub is first filled because tap water is often very cold.



# Table of Contents

<b>1.0</b>	<b>Important Hot Tub Owner Information</b> .....	<b>1</b>
<b>2.0</b>	<b>Important Safety Instructions</b> .....	<b>2</b>
<b>3.0</b>	<b>Locating Your Sundance Hot Tub</b> .....	<b>8</b>
<b>4.0</b>	<b>General Electrical Safety Instructions</b> .....	<b>9</b>
<b>5.0</b>	<b>Electrical Installation Instructions (240V Service)</b> .....	<b>11</b>
<b>6.0</b>	<b>Power Requirements</b> .....	<b>12</b>
<b>7.0</b>	<b>Start-Up Instructions</b> .....	<b>13</b>
<b>8.0</b>	<b>Operating Instructions</b> .....	<b>17</b>
8.1	View.....	17
8.2	Light.....	17
8.3	Perimeter Lights .....	17
8.4	Jets 1.....	17
8.5	Jets 2.....	17
8.6	Jets 3.....	17
8.7	Selecting The Desired Massage Action .....	18
8.8	Adjusting The Intelli-Jets .....	18
8.9	Air Controls.....	18
8.10	Optional Audio System.....	18
<b>9.0</b>	<b>Automatic Filtration Cycles</b> .....	<b>19</b>
9.1	Standard Filtration Mode .....	19
9.2	Economy Filtration Mode.....	19
9.3	Selecting “Standard” or “Economy” Filtration Mode.....	19
9.4	Preset Filter Cycles .....	20
9.5	Clean-Up Cycle.....	20
<b>10.0</b>	<b>Programming Instructions</b> .....	<b>20</b>
10.1	Adjusting Time of Day .....	20
10.2	Changing Filter Cycles .....	21
10.3	Programming Circulation Pump Run Time .....	22
10.4	Locking Filter Cycles.....	22
10.5	Panel Lock .....	22
10.6	Temperature Setting Lock .....	23
<b>11.0</b>	<b>Hot Tub Maintenance</b> .....	<b>23</b>
11.1	Cleaning the Filter .....	23
11.2	Draining and Refilling.....	25

- 11.3 Cleaning the Hot Tub Interior .....26
- 11.4 Pillow Care .....26
- 11.5 Maintaining the Wood Cabinet.....26
- 11.6 Intelli-Jet Cleaning Procedure.....27
- 11.7 Maintaining the Cover.....28
- 11.8 Winterizing .....28
- 11.9 Restarting your Hot Tub in Cold Weather .....29
  
- 12.0 Water Quality Maintenance .....29**
- 12.1 pH Control.....30
- 12.2 Sanitizing .....30
- 12.3 Other Additives .....30
- 12.4 Optional SunZone™ Water Maintenance System .....30
  
- 13.0 Troubleshooting - Display Messages .....31**
- 14.0 Troubleshooting - Procedures .....33**
- 15.0 Electrical Wiring Diagram (Domestic 60 Hz).....36**
- 16.0 Electrical Wiring Diagram (Export 50 Hz) .....37**
- 17.0 Typical Spa Wiring Diagrams A-B (Domestic 60 Hz) .....38**



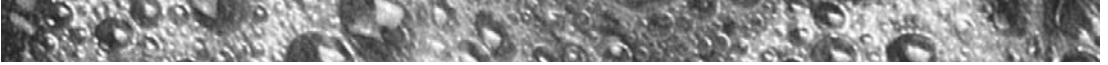
## **1.0 Important Hot Tub Owner Information**

**Your Sundance hot tub is constructed to the highest standards and is capable of providing many years of trouble-free use. However, because heat retentive materials are utilized to insulate the hot tub for efficient operation, an uncovered hot tub surface directly exposed to sunlight and high temperatures for an extended period is subject to permanent damage. Damage caused by exposing the hot tub to this abuse is not covered by warranty. We recommend that you always keep the hot tub full of water when it is exposed to direct sunlight and that you keep the Sundance insulating cover in place at all times when the hot tub is not in use. Read and carefully follow the requirements for your hot tub's support base found in the section 3.0 titled, "Locating Your Sundance Hot tub" (page 8).**

**Sundance Spas constantly strives to offer the finest hot tubs available, therefore, modifications and enhancements may be made which affect the specifications, illustrations and/or instructions contained herein.**

### **FCC Notice**

This equipment has been tested and found to comply with the limits for a Class B Digital Device, pursuant to Part 15 of the FCC Rules. These limits are designed to provide reasonable protection against harmful interference in a residential installation. This equipment generates, uses and can radiate radio frequency energy and, if not installed and used in accordance with the instructions, may cause harmful interference to radio communications. However, there is no guarantee that interference will not occur in a particular installation. If this equipment does cause harmful interference to radio or television reception, which can be determined by turning the equipment off and on, the user is encouraged to try to correct the interference by one or more of the following measures: 1) Rearrange or relocate the receiving antenna; 2) Increase the separation between the equipment and receiver; 3) Connect the equipment into an outlet on a circuit different from the circuit connected; 4) Consult the dealer or an experienced radio/TV technician for help. (Changes or modifications not expressly approved by the party responsible for FCC compliance could void the user's authority to operate this equipment.)

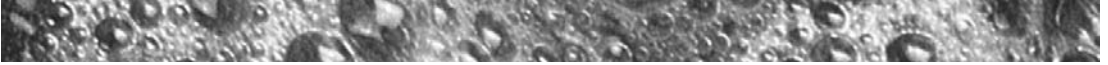


## 2.0 IMPORTANT SAFETY INSTRUCTIONS

### READ AND FOLLOW ALL INSTRUCTIONS CAREFULLY

When installing and using this electrical equipment, basic safety precautions should always be followed, including:

- 1) **WARNING:** To reduce the risk of injury, do not permit children to use this product unless they are closely supervised at all times.
- 2) **WARNING:** A grounding wire connector is provided on this unit to connect a minimum No. 8 AWG (8.4mm<sup>2</sup>) solid copper conductor between this unit and any metal equipment, metal enclosures of electrical equipment, metal water pipe, or conduit within 5 feet (1.5m) of the unit.
- 3) **DANGER:** *Risk of Accidental Drowning.* Extreme caution must be exercised to prevent unauthorized access by children. To avoid accidents, ensure that children cannot use this hot tub unless they are supervised at all times.
- 4) **DANGER:** *Risk of Injury.* The suction fittings in this hot tub are sized to match the specific water flow created by the pump. Should the need arise to replace the suction fittings or the pump, be sure that the flow rates are compatible. Never operate the hot tub if the suction fittings are broken or missing. Never replace a suction fitting with one rated less than the flow rate marked on the original suction fitting.
- 5) **DANGER:** *Risk of Electric Shock.* Install at least 5 feet (1.5m), from all metal surfaces. As an alternative, a hot tub may be installed within 5 feet of metal surfaces if each metal surface is permanently connected (bonded) by a minimum No. 8 AWG (8.4 mm<sup>2</sup>) solid copper conductor attached to the wire connector on the grounding lug, inside the equipment compartment on the equipment box.
- 6) **DANGER:** *Risk of Electric Shock.* Do not permit any electrical appliance, such as a light, telephone, radio, television, etc. within 5 feet of a hot tub unless such appliances are built-in by the manufacturer.
- 7) **ELECTRICAL SUPPLY:** The electrical supply for this product must include a suitably rated switch or circuit breaker to open all ungrounded supply conductors to comply with section 422-20 of the National Electrical Code, ANSI/NFPA 70. The disconnect must be readily accessible and visible to the hot tub occupant but installed at least 5 feet (1.5m), from the hot tub water.




8) **WARNING: To Reduce the Risk of Injury:**

- a) The water in a hot tub should never exceed 104 °F (40 °C). Water temperatures between 100 °F (38 °C) and 104 °F (40 °C) are considered safe for a healthy adult. Lower water temperatures are recommended for young children and when hot tub use exceeds 10 minutes. **Note: For exercise, the water temperature should not exceed 90 °F (32 °C).**
- b) Since excessive water temperatures have a high potential for causing fetal damage during the early months of pregnancy, pregnant or possibly pregnant women should limit hot tub water temperatures to 100 °F (38 °C). If pregnant, please consult your physician before using a hot tub.
- c) Before entering the hot tub, the user should measure the water temperature with an accurate thermometer since the tolerance of water temperature-regulating devices may vary as much as +/- 5 °F (2 °C).
- d) The use of alcohol, drugs, or medication before or during hot tub use may lead to unconsciousness with the possibility of drowning.
- e) Persons suffering from obesity or a medical history of heart disease, low or high blood pressure, circulatory system problems, or diabetes should consult a physician before using a hot tub.
- f) Persons using medication should consult a physician before using a hot tub since some medication may induce drowsiness, while other medication may affect heart rate, blood pressure, and circulation.

**IMPORTANT SAFETY INSTRUCTIONS  
(CSA SAFETY INFORMATION)**

When using this electrical equipment, basic safety precautions should always be followed, including the following:

- a) **READ AND FOLLOW ALL INSTRUCTIONS.**
- b) A green colored terminal or a terminal marked G, Gr, Ground, Grounding or the  symbol\* is located inside the supply terminal box or compartment. To reduce the risk of electric shock, this terminal must be connected to the grounding means provided in the electric supply service panel with a continuous copper wire equivalent in size to the circuit conductors that supply this equipment.

\*IEC Publication 417, Symbol 5019.



- c) At least two lugs marked “Bonding Lugs” are provided on the external surface or on the inside of the supply terminal box/compartment. To reduce the risk of electric shock, connect the local common bonding grid in the area of the hot tub to these terminals with an insulated or bare copper conductor not smaller than No. 6 AWG.
- d) All field-installed metal components such as rails, ladders, drains or other similar hardware within 10 feet (3m) of the hot tub shall be bonded to the equipment grounding buss with copper conductors not smaller than No. 6 AWG.
- e) **SAVE THESE INSTRUCTIONS.**

**WARNING:** Children should not use hot tubs without adult supervision.

**AVERTISSEMENT:** NE PAS LAISSER LES ENFANTS UTILISER LA CUVE DE RELAXATION SANS SURVEILLANCE.

**WARNING:** Do not use hot tubs unless all suction guards are installed to prevent body and hair entrapment.

**AVERTISSEMENT:** NE PAS UTILISER LA CUVE DE RELAXATION SI LES GRILLES DE PRISE D’ASPIRATION NE SONT PAS TOUTES EN PLACE. POUR EVITER QUE LES CHEVEUX OU UNE PARTIE DU CORPS SOIENT ASPIRES.

**WARNING:** People with infectious diseases should not use a hot tub.

**AVERTISSEMENT:** LES PERSONNES ATTEINTES DE MALADIES INFECTIEUSES NE DEVRAIENT PAS UTILISER LA CUVE DE RELAXATION.

**WARNING:** To avoid injury, exercise care when entering or exiting the hot tub.

**AVERTISSEMENT:** POUR EVITER DES BLESSURES, SOYEZ PRUDENT EN ENTRANT ET SORTANT DE LA CUVE DE RELAXATION.

**WARNING:** Do not use drugs or alcohol before or during the use of a hot tub to avoid unconsciousness and possible drowning.





**AVERTISSEMENT:** *POUR EVITER L'EVANOUISSEMENT ET LA NOYADE EVENTUELLE, NE PRENDRE NI DROGUE NI ALCOOL AVANT D'UTILISER LA CUVE DE RELAXATION NI QUAND ON S'Y TROUVE.*

**WARNING:** Pregnant or possibly pregnant women should consult a physician before using a hot tub.

**AVERTISSEMENT:** *LES FEMMES ENCEINTES, QUE LEUR GROSSESSE SOIT CONFIRMEE OU NON, DEVRAIENT CONSULTER UN MEDECIN AVANT D'UTILISER LA CUVE DE RELAXATION.*

**WARNING:** Water temperature in excess of 40 °C (104 °F) may be injurious to your health.

**AVERTISSEMENT:** *IL PEUT ETRE DANGEREUX POUR LA SANTE DE SE PLONGER DANS DE L'EAU A PLUS DE 40 °C.*

**WARNING:** Before entering the hot tub, measure the water temperature with an accurate thermometer.

**AVERTISSEMENT:** *AVANT D'UTILISER UNE CUVE DE RELAXATION MESURER LA TEMPERATURE DE L'EAU A L'AIDE D'UN THERMOMETRE PRECIS.*

**WARNING:** Do not use a hot tub immediately following strenuous exercise.

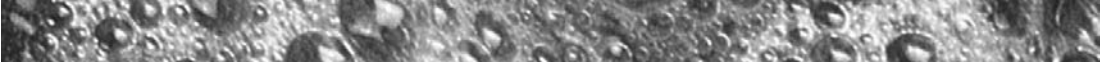
**AVERTISSEMENT:** *NE PAS UTILISER LA CUVE DE RELAXATION IMMEDIATEMENT APRES UN EXERCICE FATIGANT.*

**WARNING:** Prolonged immersion in a hot tub may be injurious to your health.

**AVERTISSEMENT:** *RESTER TROP LONGTEMPS DANS LA CUVE DE RELAXATION PEUT ETRE DANGEREUX POUR LA SANTE.*

**WARNING:** Do not permit electric appliances (such as lights, telephone, radio, television, etc.) within 5 feet (1.5m) of this hot tub unless such appliances are built-in by the manufacturer.

**AVERTISSEMENT:** *NE PAS PLACER D'APPAREIL ELECTRIQUE (LUMINAIR, TELEPHONE, RADIO, TELEVISEUR, ETC.) A MOINS DE 1.5M DE LA CUVE DE RELAXATION, SAUF SI INSTALLÉ À LA MANUFACTURE.*



**CAUTION:** Maintain water chemistry in accordance with manufacturer's instructions.

**ATTENTION:** LA TENEUR DE L'EAU EN MATIERES DISSOUTES DOIT ETRE CONFORME AUX DIRECTIVES DU FABRICANT.

**WARNING:** The use of alcohol or drugs can greatly increase the risk of fatal hyperthermia in hot tubs.

**AVERTISSEMENT:** LA CONSOMMATION D'ALCOOL OU DE DROGUE AUGMENTE CONSIDERABLEMENT LES RISQUES D'HYPERTHERMIE MORTELLE DANS UNE CUVE DE RELAXATION.

## **SAVE THESE INSTRUCTIONS**

### **HYPERTHERMIA**

Prolonged immersion in hot water may induce hyperthermia. A description of the causes, symptoms, and effects of hyperthermia are as follows:

Hyperthermia occurs when the internal temperature of the body reaches a level several degrees above the normal body temperature of 98.6°F (37°C). The symptoms of hyperthermia include drowsiness, lethargy, and an increase in the internal temperature of the body. The effects of hyperthermia include:

- a) Unawareness of impending hazard;
- b) Failure to perceive heat;
- c) Failure to recognize the need to exit hot tub;
- d) Physical inability to exit hot tub;
- e) Fetal damage in pregnant women; and
- f) Unconsciousness and danger of drowning.

**A warning sign is provided in your warranty packet. Please install it at a location near your spa, where it is visible to the user of the hot tub. For additional or replacement signs please contact your local Sundance Spas dealer and reference item number #6530-082.**



## **Cautions**

1. Persons suffering from heart disease, diabetes, high or low blood pressure, and any condition requiring medical treatment, pregnant women, the elderly, or infants should consult with a physician before using a hot tub.
2. The Consumer Products Safety Commission has stated that the water temperature in a hot tub should not exceed 104 °F (40 °C). Immersion in water in excess of 104 °F (40 °C) can be hazardous to your health.
3. Observe a reasonable time limit when using the hot tub. Long exposures at higher temperatures can cause high body temperature. Symptoms may include dizziness, nausea, fainting, drowsiness, and reduced awareness. These effects could possibly result in drowning.
4. Do not use the hot tub under the influence of alcohol, narcotics, or other drugs. Use of the hot tub under these conditions may lead to serious consequences.
5. Always test the hot tub water temperature before entering the hot tub. Enter and exit the hot tub slowly. Wet surfaces can be very slippery.
6. Never bring any electrical appliances into or near the hot tub. Never operate any electrical appliances from inside the hot tub or when you are wet unless such appliances are built-in by the manufacturer.
7. Proper chemical maintenance of hot tub water is necessary to maintain safe water and prevent possible damage to hot tub components.
8. Use the straps and clip tie downs to secure the cover when not in use. This will help to discourage unsupervised children from entering the hot tub and keep the hot tub cover secure in high-wind conditions. There is no representation that the cover, clip tie-downs, or actual locks will prevent access to the hot tub.
9. For exercise, the water should not exceed 90 °F (32 °C).



### 3.0 Locating Your Sundance Hot tub

**IMPORTANT:** Because of the combined weight of the hot tub, water and users, it is extremely important that the base upon which the hot tub rests be smooth, flat, level and capable of uniformly supporting this weight, without shifting or settling, for the entire time the hot tub is in place. If the hot tub is placed on a surface which does not meet these requirements, damage to the skirt and/or the hot tub shell may result. Damage caused by improper support is not covered under warranty. It is the responsibility of the hot tub owner to assure the integrity of the support at all times.

We recommend a poured, reinforced concrete slab with a minimum thickness of 4 inches (10 cm). Wood decking is also acceptable provided it is constructed so that it meets the requirements outlined above.

The hot tub must be installed in such a manner as to provide drainage away from the hot tub. Placing the hot tub in a depression without provisions for proper drainage could allow rain, overflow and other casual water to flood the equipment and create a wet condition in which it would sit.

For hot tubs which will be recessed into a floor or deck, install so as to permit access to the equipment, either from above or below, for servicing. Make certain that there are no obstructions which would prevent removal of the cabinet side panels, especially on the side with the equipment bay doors.

In selecting the ideal *outdoor* location for your hot tub, we suggest that you take into consideration 1) the proximity to changing area and shelter (especially in colder weather); 2) the pathway to and from your hot tub (this should be free of debris so that dirt and leaves are not easily tracked into the hot tub); 3) the closeness to trees and shrubbery (remember that leaves and birds could create extra work in keeping the hot tub clean); 4) a sheltered environment (less wind and weather exposure can result in lowered operation and maintenance costs); and 5) the overall enhancement of your environment. It is preferable *not* to place the hot tub under an unguttered roof overhang since run-off water will shorten the life expectancy of the hot tub cover.

For *indoor* installations, be certain to make provisions for proper ventilation. When the hot tub is in use, considerable amounts of moisture will escape. This can damage certain surfaces over time.

If you have any questions regarding the placement or installation of your hot tub, consult your Sundance Dealer.

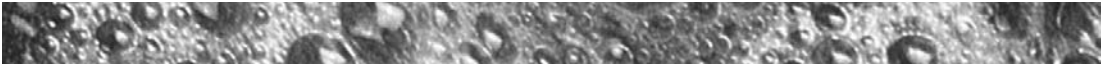


## **4.0 General Electrical Safety Instructions**

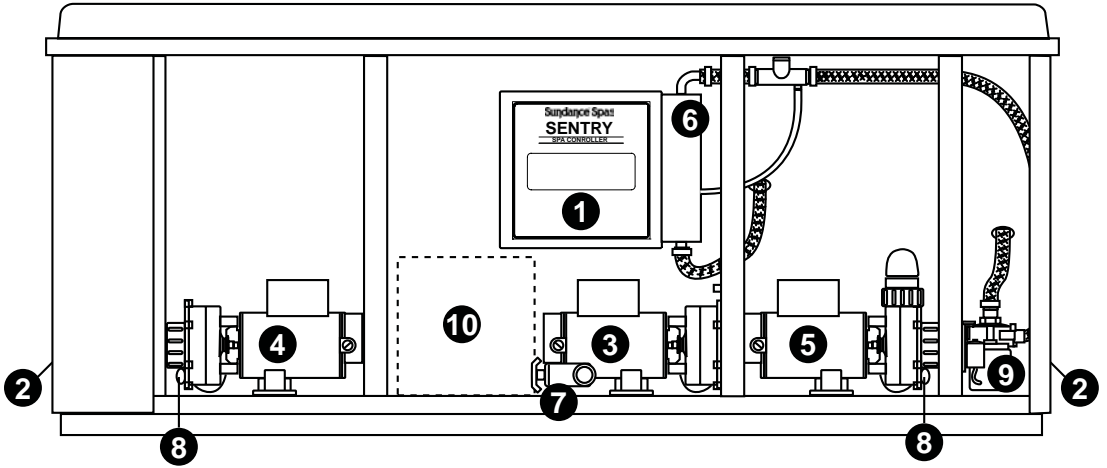
Your new Sundance hot tub is equipped with the "state-of-the-art" Sentry™ equipment system. It contains the most advanced safety and self-protective equipment in the industry. Nonetheless, this hot tub must be installed properly to insure dependable usage. Please contact your dealer or local building department should you have any questions regarding your installation.

Proper grounding is extremely important. Sundance hot tubs are equipped with a current collector system. A pressure wire connector is provided on the surface of the control box, located inside the equipment door (Figure-B, Page 10) to permit connection of a bonding wire between this point and any ground metal equipment, metal water pipe or conduit within 5 feet (1.5m) of the hot tub, or copper clad grounding rod buried within 5 feet (1.5m) of the hot tub. Bonding wire must be at least No. 8 AWG (8.4 mm<sup>2</sup>) solid copper wire. This is a most important safety assurance feature.

Before installing this hot tub, check with the local building department to insure installation conforms to local building codes.

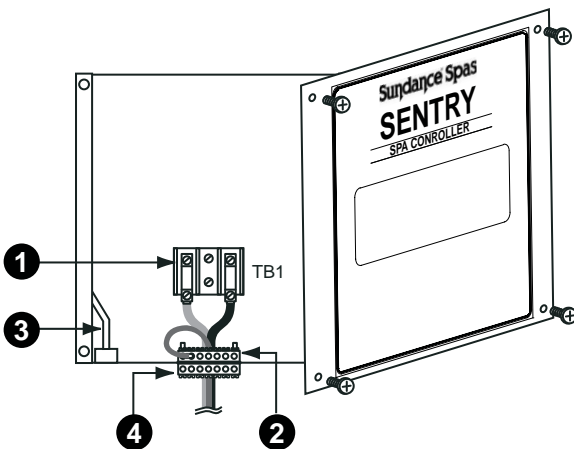


**Figure-A**  
**Equipment Area**



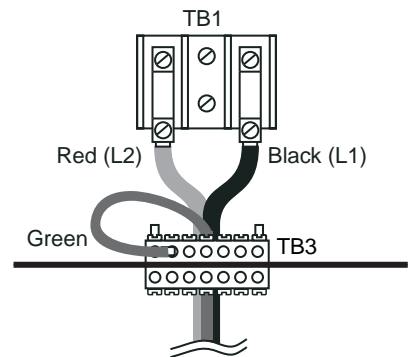
- |                              |   |
|------------------------------|---|
| 1. Sentry Control Box        | 7. Hot Tub Drain  |
| 2. Power Supply Entrance(s)  | 8. Pump Drain Plug(s)   |
| 3. Pump #1 (2-Speed)         | 9. Circulation Pump   |
| 4. Pump #2 (High Speed Only) | 10. Optional Subwoofer Behind Bulkhead (Models with Audio Option Only.) |
| 5. Pump #3 (High Speed Only) |   |
| 6. Heater                    |   |

**Figure-B**  
**Sentry Control Box**



1. Terminal Block
2. Bonding Lug
3. Receptacle for Optional Ozone Purification System
4. Grounding Terminal

**Figure-C**  
**Terminal Block**  
**240V Wire Connection**

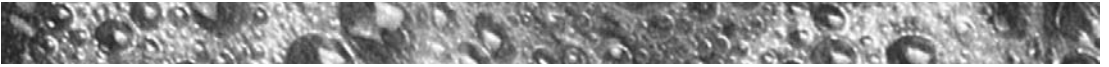




## 5.0 Electrical Installation Instructions (240V Service)

**IMPORTANT NOTICE:** The electrical wiring of this hot tub must meet the requirements of the National Electrical Code (NEC) and any applicable state or local codes. The electrical circuit must be installed by a qualified electrician and approved by a local building/electrical inspection authority.

1. This hot tub must be permanently connected (hard-wired) to the power supply. **No plug-in connections or extension cords are to be used in conjunction with the operation of this hot tub.** Supplying power to the hot tub which is not in accordance with these instructions will void both the independent testing agency listing and the manufacturer's warranty.
2. The power supplied to this hot tub *must* be a *dedicated* circuit with no other appliances or lights sharing the power provided by the circuit.
3. To determine the current, voltage and wire size required, refer to section 3.0 "Power Requirements" (page 12).
  - Wire size must be appropriate per NEC and/or local codes.
  - We recommend type THHN wire.
  - All wiring must be copper to ensure proper connections. **Do not use aluminum wire.**
  - When using wire larger than #6, add a junction box near the hot tub and reduce to short lengths of #6 wire to connect to the hot tub.
4. The electrical supply for this product must include a suitably rated switch or circuit breaker to open all ungrounded supply conductors to comply with Section 422-20 of the National Electrical Code, ANSI/NFPA 70. The disconnecting means must be readily accessible to the hot tub's occupant but installed at least 5 feet (1.5m) from hot tub water.
5. The electrical circuit supplied for the hot tub must include a suitable ground fault circuit interrupter (GFCI) as required by NEC Article 680-42.
6. To gain access to the hot tub's power terminal block, remove the four screws securing the center cabinet panel on the side of the hot tub under the controls. Then remove the four control box door screws and door (Figure B).



7. Select the power supply entrance you want to use (Figure-A, page 10) and remove the short cabinet panel from the front of the hot tub to allow you to feed the cable through to the control box. Install the cable with connector through the large opening provided in the bottom of the control box.
8. Connect wires, color to color, on terminal blocks TB1 and TB3 (Figure-C, page 10). TIGHTEN SECURELY! All wires must be hooked up securely or damage could result.
9. Install control box door and reinstall the cabinet side panels.

## 6.0 Power Requirements

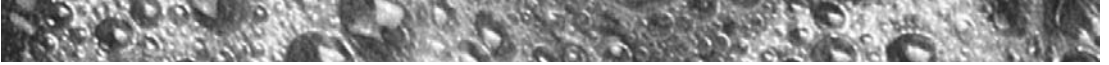
Sundance hot tubs are designed to provide optimum performance and flexibility of use when connected to the maximum electrical service as listed below. However, they are shipped configured for 60A, 240V for domestic 60 Hz models or 45A, 230V for Export 50 Hz models. If you prefer, your Sundance dealer can perform a minor circuit board modification to allow the hot tub to accept different electrical service. The operational considerations of these modifications are listed in the footnotes below.

<u>Domestic</u>	<u>240V/40A</u> **	<u>240V/50A</u> *	<u>240V/60A</u> ***
Voltage	240 volts	240 volts	240 volts
Current Draw	32 amps	40 amps	48 amps
Number of Wires	Three	Three	Three
Circuit Breaker	40 amp, 2-pole	50 amp, 2-pole	60 amp, 2-pole
<u>Export</u>	<u>230V/40A</u> **	<u>230V/45A</u> *	<u>230V/50A</u> ***
Voltage	230 volts	230 volts	230 volts
Current Draw	26 amps	34 amps	42 amps
Number of Wires	Three	Three	Three
Circuit Breaker	40 amp, 2-pole	45 amp, 2-pole	50 amp, 2-pole

\* In this configuration, the heater **will not operate** while any two pumps are operating at high speed. *Note: pump #2 and pump #3 run only in high speed.*

\*\* In this configuration, the heater **will not operate** at the same time as any high speed pump. *Note: pump #2 and pump #3 run only in high speed.*





**\*\*\***In this configuration the heater **turns off** when all three pumps are operating in high speed. *Note: pump #2 and pump #3 run only in high speed.*

## **7.0 Start-Up Instructions**

**FOR BEST RESULTS, READ EACH STEP IN ITS ENTIRETY BEFORE PROCEEDING WITH THAT STEP.**

### **A. Prepare The Hot Tub For Filling**

- Clear all debris from the hot tub. (Although the hot tub shell has been polished at the factory, you may want to treat it with a specially formulated hot tub cleaner and wax available from your dealer prior to filling the first time.)
- Remove the filter lid (Figure-F, page 16), then remove filter cartridge as illustrated in section 11.1, page 23.

### **B. Fill Hot Tub**

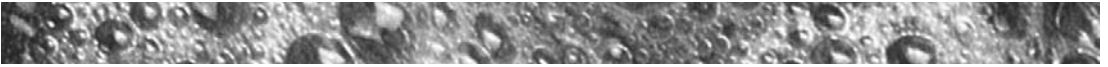
- Place the end of your garden hose into the filter pipe exposed when you removed the filter cartridge.

**NOTE:** *Never fill with water from a water softener. If your water is extremely "hard", it is preferable to fill half-way with hard water and the rest of the way with softened water. Or, you may fill entirely with hard water if you use a special water additive available from your Sundance dealer.*

- Fill the hot tub until the water level is midway in the skimmer opening and above all jets. **Do not overfill.**

**Important:** Always fill your hot tub through the filter pipe after draining. Failure to do so may cause air to be trapped in the pump, preventing the pump from circulating water.

- Remove the hose and replace the filter cartridge as illustrated in section 11.1, page 23.



### C. Turn On Power

Turn on power to hot tub at the home's circuit breaker. The heater and low speed pump #1 automatically activate and the control panel LCD flashes water temperature and "COOL" or "ICE" (page 31-32).

### D. Activate Jets

Depress the **JETS 1** sensor pad on the control panel once to activate pump #1 in low speed; then press a second time for high speed.



### E. Add Start-Up Chemicals

Add the hot tub water chemicals as recommended by your Sundance Dealer. See section titled "WATER QUALITY MAINTENANCE" (page 29) for general guidance.

### F. Set Hot Tub To Heat

To warm hot tub water to a comfortable temperature, follow these steps:

- The LCD display on the control panel displays the actual temperature of the hot tub water. Press either the **COOLER** (Down) or **WARMER** (Up) sensor pad once to display the "set" temperature for 5 seconds. If you want the water to heat to a different temperature, simply press **COOLER** or **WARMER** within 5 seconds. The set temperature advances or decreases by one degree each time one of these sensor pads is pressed.
- The heater will turn off when the temperature corresponding to the thermostat setting is achieved.

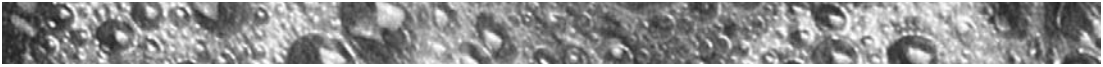


#### ***Important Heater Details:***

- *The maximum temperature for which the hot tub can be set is 104 °F (40 °C) and the minimum is 80 °F (27 °C).*
- *If hot tub is hooked up to 40 amp service - turn off all high speed pumps to operate heater. Note: pumps #2 and pump #3 run only in high speed.*
- *Setting the thermostat at maximum will not accelerate the heating process. This will only result in a higher ultimate temperature.*
- *The heater operates until the water reaches the programmed "set temperature", then turns off. The heater will reactivate after the water cools to approximately 1.5° below the "set temperature."*

### G. Place Cover On Hot Tub

- Keeping the insulating cover in place anytime the hot tub is not in use will reduce the time required for heating, thereby minimizing operating costs.
- The time required for initial heat-up will vary depending on the starting water temperature.



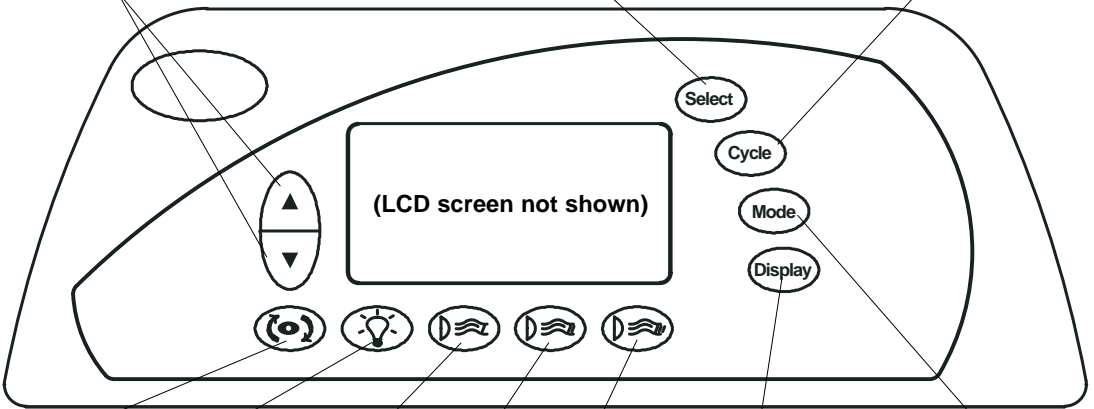
**DANGER. RISK OF INJURY. ALWAYS CHECK WATER TEMPERATURE CAREFULLY BEFORE ENTERING HOT TUB. DO NOT EXERCISE IN WATER ABOVE 90 DEGREES F (32 °C).**

**Figure -D  
COMMAND CENTER**

These display temperature setting and increase or decrease temperature setting and other programmable features.

Accesses filter cycle program mode and advances display to next cycle.

Scrolls menu through filter cycle programming features.



Inverts the main 4-digit display.

Controls the hot tub light (bright, dim, dimmer, off).

Controls 2-speed Pump #1.

Controls high speed pump #2.

Controls high speed Pump #3.

Displays time of day and initiates time setting and locking functions.

Switches between standard and economy modes (page 19).

**Figure-E  
LCD SCREEN**

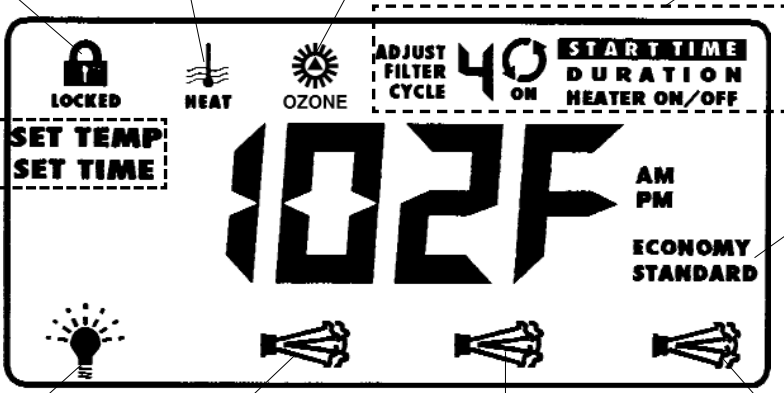
Indicates panel, set temperature or filter cycle programming locked.

Indicates heater is on (page 14)

Indicates optional SunZone™ sanitizer is on.

Indicates filter cycle in progress or displays cycle programming features (page 19).

These characters identify what is being shown on the main 4-digit display



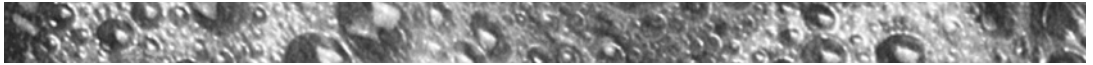
Indicates operating mode selected (page 19).

Indicates hot tub light is on (changes according to brightness selected).

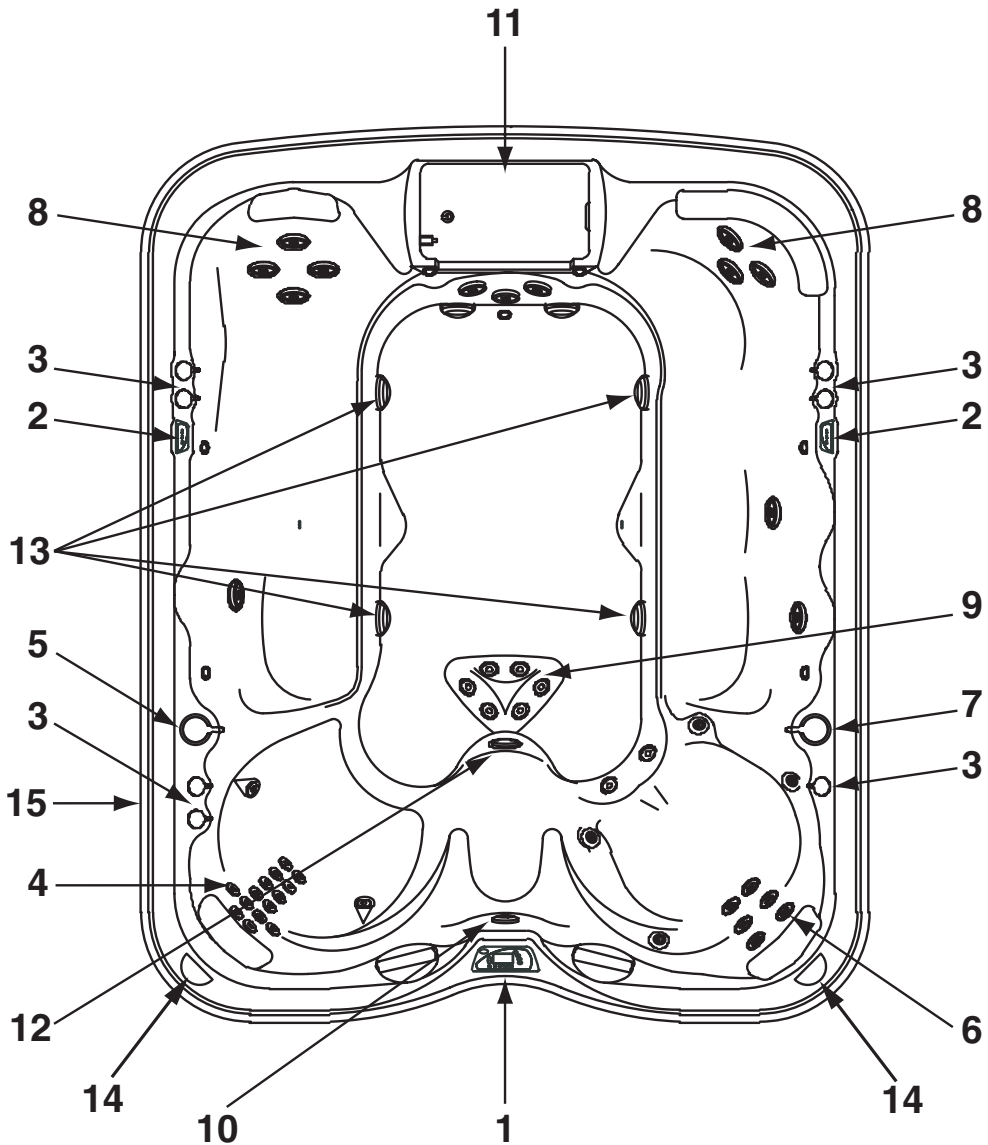
Indicates 2-speed pump #1 is on. Icon appearance does not change from high to low speed.

Indicates high speed pump #2 is on.

Indicates high speed pump #3 is on.



**Figure -F**  
**Hot Tub Top View**



- |                                |   |
|--------------------------------|---|
| 1. Control Panel               | 10. Light                                     |
| 2. Auxiliary Control Panels    | 11. Filter Lid                                |
| 3. Air Controls                | 12. Heater Return                             |
| 4. Therapy Seat "A"            | 13. Footwell Suction Fittings and Filters     |
| 5. Massage Selector Valve "A"  | 14. Optional Audio System Speakers (2 places) |
| 6. Therapy Seat "B"            | 15. Optional Audio System Receiver.           |
| 7. Massage Selector Valve "B"  |   |
| 8. Therapy Jets (Intelli-Jets) |   |
| 9. Vertical Jets               |   |



## 8.0 Operating Instructions

Your Sundance hot tub has a touch-sensitive control panel, massage selector valves and air control knobs located on the top rim of the hot tub (Figure-F, page 16). These controls let you operate many of the special functions of your Sundance hot tub. By familiarizing yourself with the following information, you will be able to gain the full benefit afforded by the various functions of your hot tub.

### 8.1 View

Pressing this sensor pad inverts the main four-digit display on the Command Center's LCD screen to allow easy reading from either inside or outside the hot tub.



### 8.2 Light

The **LIGHT** sensor pad activates both the underwater light and the light symbol on the LCD screen when touched. To reduce the brightness of the light, touch the sensor pad again. A third touch will result in an even lower level of illumination. A fourth touch turns the light off. If left on, the light will automatically turn off after one hour.



The optional SunGlow™ Multi-Colored LED Light Kit (#6560-240) can retrofit the factory installed spa light. This option offers 7 light colors and a unique random mode for enhanced spa enjoyment. Consult your Sundance Dealer for additional information.

### 8.3 Perimeter Lights

Both perimeter lights contain a photocell that senses the presence of sunlight; automatically turning them on at sunset and off at sunrise. Both lights also utilize a long-life, 10-year LED light bulb for added convenience.



**8.4 Jets 1:** The sensor pad labeled **JETS 1** controls the 2-speed pump #1. Press once for low speed. Press a second time for high speed. Press a third time to turn off.

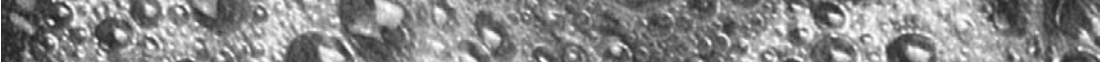


**8.5 Jets 2:** The sensor pad labeled **JETS 2** controls pump #2. *Note: this pump runs only in high speed.*



**8.6 Jets 3:** The sensor pad labeled **JETS 3** controls pump #3. *Note: this pump runs only in high speed.*





**Auto Turn Off** - Anytime a jet pump has been manually turned on, it will automatically turn off after approximately 20 minutes. If at this time you desire more jet operation you may simply turn the pump(s) back on.

## 8.7 Selecting The Desired Massage Action

Your Sundance hot tub is equipped to allow you the customized massage action you desire. By simply diverting the massage selectors “A” and “B” you control a full range of therapeutic pressures to each therapy seat independently. Both the Intelli-jets and therapy seat “B” are fully adjustable by allowing a wide range of speed and flow control right at the jetface. **Note: always keep at least 6 adjustable jets open at the same time.**



## 8.8 Adjusting The Intelli-Jets

With the nozzles of the Intelli-Jets positioned straight ahead, the jet stream will be stationary. Pushing the nozzle to one side causes the jet nozzle to rotate, moving the jet stream in a circular pattern. The speed of the rotation and volume of water flow can be adjusted by rotating the jetface.

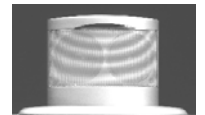
## 8.9 Air Controls

Each jet system has its own air control. These controls allow you to regulate the amount of air which is mixed with the water entering through the jets. Clockwise rotation adds more air and counterclockwise rotation reduces air flow. To minimize heat loss, these controls should be closed when the hot tub is not in use.

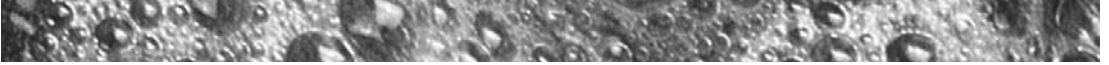


## 8.10 Optional Audio System

Sundance models with the optional audio system offer enhanced spa enjoyment by offering an integrated state-of-the-art audio system. These models include two high-quality marine speakers and an integrated subwoofer for long-life and an excellent sound quality. Refer to the manufacturer supplied instruction manual located in your warranty pack for detailed audio receiver usage instructions.



Two speakers located at each spa corner (Figure-F, page 16) are designed for manual exposure and retraction. To expose each speaker for audio playback, simply press down on each enclosure to unlatch its “pop-up” mechanism, then release. To retract each speaker before covering spa, gently press downward on each enclosure until you feel a slight “click”, then release.



**CAUTION:** Never step or sit on a speaker enclosure! This type of misuse will damage the speaker enclosure latching and track mechanism. Always retract speakers prior to covering spa.

**CAUTION:** *Never submerge the supplied wireless remote control under water or leave it under the spa cover!* The wireless remote control is *water-resistant* but not *waterproof*! Never submerge the remote control under water for any reason. Also, never leave the remote inside the spa while covered. Moisture under the spa cover will damage the remote control! Damage caused by this type of misuse will void the manufacturer's warranty on the remote control.

## 9.0 Automatic Filtration Cycles

Your Sundance Sentry™ controls have been designed to provide maximum convenience, as well as economy of operation. By selecting the appropriate filtration mode, you can ensure that your hot tub will be ready to use anytime with the lowest possible energy consumption.

Your spa's control system activates automatic filter cycles, during which pump #1 turns on in low speed to move water through the filter. This water movement also provides important skimming action to remove debris and suspensions from the water's surface, minimizing the "bathtub ring" effect.

### 9.1 Standard Filtration Mode

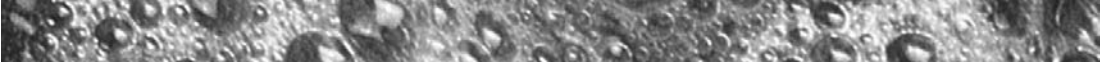
In standard mode, water temperature is held to the set temperature by the circulation pump and heater which turns on as needed to maintain the set temperature. After the set temperature is reached, the heater turns off and the circulation pump continues to operate continuously to filter and clean the spa water, unless programmed otherwise (sec. 10.3, page 22).

### 9.2 Economy Filtration Mode

In economy mode, the low speed pump #1 and heater turn on only during a programmed filter cycle or when either JETS sensor is pressed. *Note: you can change pump #1 to high speed or turn it off during a filter cycle, however, it will automatically revert back to low speed in 20 minutes for the duration of the filter cycle.*

### 9.3 Selecting "Standard" or "Economy" Filtration Mode

Press the **MODE** button to select either "Standard" or "Economy" mode. The control panel's indicator on the right side of the LCD changes to indicate which mode is selected. When an automatic filter cycle activates, the LCD screen displays the following message:



## **FILTER CYCLE                      ON**

**Summer Logic:** *In warm weather, the water temperature in the hot tub may exceed the set temperature. This condition may occur due to heat transference from the main pump and 24-hour circulation pump. If the water temperature is higher than 95°F (35°C) and rises two degrees above the set temperature, a “Summer Logic” condition occurs that deactivates the circulation pump and ozonator (if equipped). **This safety feature cannot be altered!** The circulation pump and ozonator will remain off until the water temperature cools to the set temperature (except between 12AM-2AM when the circulation pumps runs for it’s manditory 2-hour “clean-up” cycle). To help prevent a “Summer Logic” condition, it may be necessary to reduce filter cycle and/or circulation pump run times in warm weather.*

### **9.4 Preset Filter Cycles**

Your hot tub comes with four 30-minute filter cycles already programmed in, beginning at 6:00 a.m., noon, 6:00 p.m., and midnight. You can easily change the start time, or the cycle length for any of these cycles to suit your individual needs by following the steps in the next section.

### **9.5 Clean-Up Cycle**

The clean-up cycle is once per day in both Standard and Economy mode at 12:00 PM for two minutes. This is not user programmable. Pump #2 and pump #3 activate for one minute to circulate any water in the plumbing. After 1 minute they both go off and pump #1 runs for 1 minute. If the filter cycle is also set at 12:00 PM pump #1 will continue to run for the duration of the filter cycle.

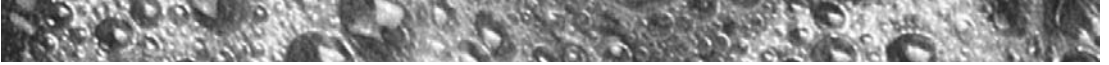
## **10.0 Programming Instructions**

### **10.1 Adjusting Time of Day**

The Sentry control system remembers the time of day even in the event of a prolonged power outage. However, it may occasionally be necessary to reset the time of day. For example: if you are not in the Pacific Time Zone you will want to reset the time for your own time zone. (The system will automatically adjust to and from daylight savings time.)

To accomplish this, press **DISPLAY, MODE** and **DISPLAY** within five seconds each. A number representing the hour will be displayed, followed by **AM** or **PM**. The hour will advance or decrease each time **UP** or **DOWN** is pressed





within five seconds. Then, press **DISPLAY** again to display the minutes. Adjust the minutes as necessary by pressing **UP** or **DOWN**. After 5 seconds, the display will return to normal.

## 10.2 Changing Filter Cycles

The Sentry Control System allows you to easily adjust two separate aspects of each of the filtration cycles (1) the time of day at which each cycle begins, (2) the duration of each cycle.

To make adjustments, first press **CYCLE** to enter the filter cycle programming mode. The LCD screen will display the following in the upper right corner:

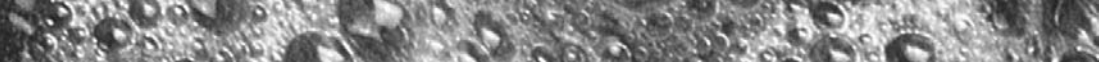
**ADJUST  
FILTER  
CYCLE**

**START TIME**

This means the system is ready to accept your changes to the start time for filter cycle number one. Simultaneously, the large four-digit display in the center of the screen displays the currently programmed start time for that filtration cycle. At this point, you have four options. You may:

- (1) Press **UP** or **DOWN** to adjust the start time in increments of 30 minutes.
- (2) Press **CYCLE** to display and adjust each subsequent filter cycle start time. With each press, the currently programmed status will be shown in the large four digit display. To adjust any displayed value, simply press **UP** or **DOWN**.
- (3) Press **SELECT** to move down the menu from Start Time to Duration, with each press, the currently programmed duration will be shown in the large four-digit display. Press **UP** or **DOWN** to adjust the duration in increments of 15 minutes.
- (4) Press **DISPLAY** to make the filter cycle programming characters disappear from the screen and the main display return to showing the water temperature. If no sensor is pressed within 30 seconds, the screen automatically returns to the standard water temperature display.

At any time, you may check the programming of any aspect of any filter cycle by first pressing **CYCLE** then moving through the menu by pressing either **CYCLE** or **SELECT**. The programming is changed only by pressing **UP** or **DOWN** during this process.



### 10.3 Programming Circulation Pump Run Time

The Sentry control system allows you to easily adjust two separate aspects of circulation pump operation:

1. The time of day (start time) the circulation pump turns on.
2. The length of time (duration) the circulation pump operates.

The factory default start time is 12:00AM (Midnight). The default duration is 24 hours. To make adjustments, press the sensor labeled **CYCLE** five times to enter the circulation pump programming mode. The LCD screen will display **ADJUST Circ.** At this time the system is ready to accept your changes.

- Press the **SELECT** sensor once. The previously programmed start time appears on the LCD display.
- Press **UP** or **DOWN** sensors to adjust the start time in 30-minute increments.
- Press the **SELECT** sensor to program duration.
- Press **UP** or **DOWN** sensors to program the duration time in 2 hour increments.
- Press **DISPLAY** to make the circulation pump programming characters disappear from the screen and the main display return to showing the water temperature. If no sensor is pressed within 30 seconds, the screen will automatically return to the normal water temperature display

**Please Note:** The circulation pump automatically activates if the spa requires heat regardless of programmed start time and duration.

### 10.4 Locking Filter Cycles

You may keep the filter cycle programs from being inadvertently altered by electronically “locking” them. To accomplish this, simply press **CYCLE** then, within 30 seconds, press **DISPLAY, MODE** and **UP**, within five seconds each. A padlock symbol will appear on the screen. In this state, the status of the cycle programming may be checked, but may not be altered.



To unlock the filter cycle programming to make changes, simply press **DISPLAY, MODE** and **DOWN** within five seconds each.

### 10.5 Panel Lock

To help prevent unauthorized use of your hot tub, the Sentry controls incorporate a unique panel locking system which disables the controls on the panel.



**To Lock The Panel:** Press the **DISPLAY, MODE,** and **UP** sensor pads, in order, within five seconds. A padlock symbol will appear on the LCD screen. With the panel locked, none of the components can be turned on and the only settings that can be adjusted are the standard/economy operating mode and changing the time of day. All automatic hot tub functions will operate normally.



**To Unlock The Panel:** Press **DISPLAY, MODE,** and **DOWN,** in order, within five seconds. The “lock” symbol will disappear. All sensor pads are now active.

## 10.6 Temperature Setting Lock

To electronically lock the temperature setting, first enter the “temperature setting” mode by pressing **UP** or **DOWN.** Then, within five seconds, press the three sensors described under “Panel Lock” above. This will prevent the temperature setting from being changed by unauthorized persons but all other sensors will remain active.

To unlock the temperature setting so that it can be adjusted, simply follow the instructions above under **“To Unlock The Panel.”**

## 11.0 Hot Tub Maintenance

Proper and regular maintenance of your hot tub will help it retain its beauty and performance. Your authorized Sundance Dealer can supply you with all the information, supplies, and accessory products you will need to accomplish this.

### 11.1 Cleaning The Filter

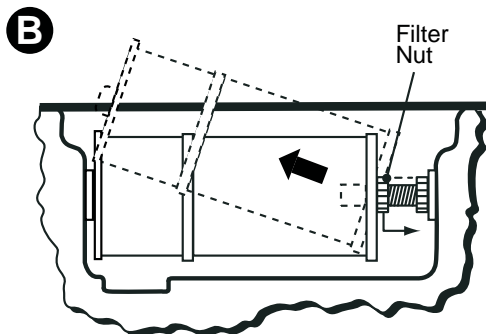
Your Sundance hot tub is equipped with an exclusive MicroClean™ 2-stage filter located under the filter lid (Figure-F, Page 16). Fine debris are filtered 24-hours by the circulation pump drawing water through the ultra-fine (stage 2) cartridge. Larger debris are filtered by the main 2-speed pump drawing water through the (stage 1) polyester mesh cartridge during normal operation and during each filter cycle. Combined, both filter halves work together to give you unsurpassed water quality by trapping suspended particles on their outer surface.

To ensure optimum performance, clean and reuse the stage 1 cartridge once a month and replace the stage 2 cartridge every 3 months. ***ALWAYS TURN POWER TO THE HOT TUB OFF BEFORE CLEANING THE FILTER***

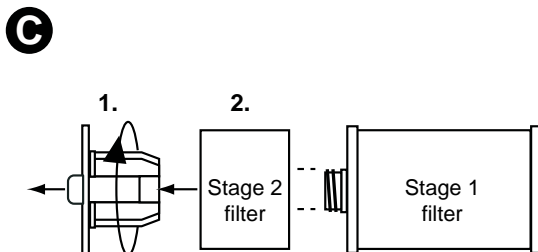


**CARTRIDGE!** To accomplish this, refer to the filter cleaning/replacement procedure:

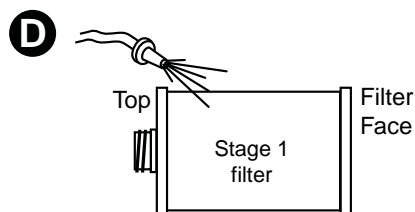
**A**  **TURN POWER TO HOT TUB OFF!** 



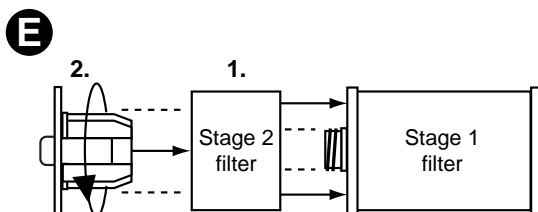
Loosen filter nut to provide clearance, then remove filter assembly.



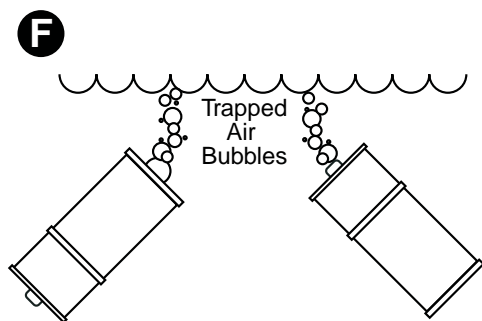
1. Rotate stage 2 retainer **counterclockwise** to release, then separate filter assembly.
2. Replace stage 2 filter after 3 months use or as needed.



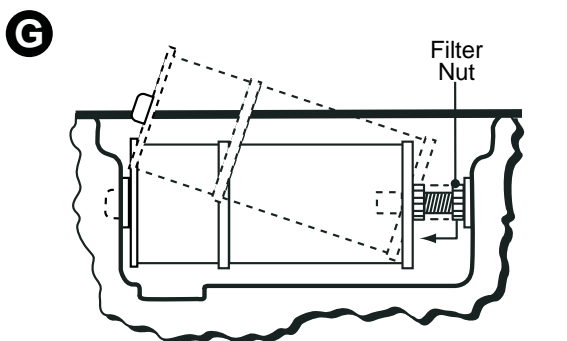
Rinse debris from the stage 1 filter pleats using a garden hose and high-pressure nozzle. Start at the top and work downward to the face. Repeat process until all filter pleats are clean.



1. Install stage 2 filter onto clean stage 1 filter.
2. Insert retainer into stage 2 filter and rotate **clockwise** to assembly. **DO NOT** overtighten retainer (finger tight only).

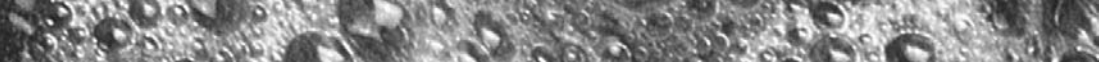


Submerge assembled filter in spa and tilt each end upward to remove trapped air bubbles from inside each filter cavity.



1. Install filter assembly, then tighten filter nut so it just touches filter face. **DO NOT OVERTIGHTEN!**
2. Turn power to hot tub back on.

Periodically, the stage 1 filter will need a more thorough cleaning to remove imbedded oils and minerals. For this, we suggest cleaning as illustrated above (step D), followed by soaking the filter overnight in a plastic container filled with a solution of water and a specially formulated filter cleanser available from your Sundance dealer.



The average life expectancy of the stage 1 filter is approximately two years with proper care and water quality maintenance. The stage 2 filter cannot be cleaned and must be replaced every 3-months, or as needed. Replacement cartridges may be purchased from your Sundance dealer.

**NOTE:** Nylon suction filters need to be cleaned periodically for optimum performance of all Jets (See Figure-F, page 16).

## 11.2 Draining And Refilling

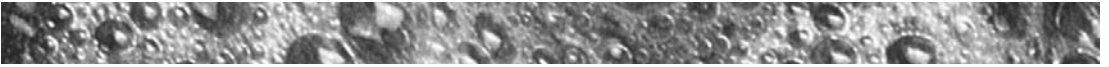
About every 3 to 6 months, you will want to replace the hot tub's water. The frequency depends on a number of variables including the amount of use, attention paid to water quality maintenance, etc. You will know it is time for a change when you cannot control sudsing and/or you can no longer get the normal feel or sparkle to the water even though the key water balance measurements are all within the proper parameters.

**CAUTION! READ THIS BEFORE DRAINING:** *To prevent damage to the hot tub's components, **turn off power to the hot tub at the circuit breaker before draining it.** Do not turn the power back on until your hot tub has been refilled.*

**CAUTION:** *There are certain precautions to keep in mind when draining your hot tub. If it is extremely cold, and the hot tub is outdoors, freezing could occur in the lines or the equipment (see "WINTERIZING" page 28). On the other hand, if it is hot outdoors, do not leave the hot tub's surface exposed to direct sunlight for long periods.*

To drain your hot tub using the drain port provided, **first turn off the power to the hot tub at the circuit breaker.** Then remove the center panel from the side of the cabinet under the control panel. The drain port is secured to the base inside the door and features a white "T" handle (Figure-A, page 10). To attach a garden hose, replace the fitting screwed into the end of the drain port with the fitting provided with your hot tub (in the plastic bag with your colored lenses). For faster draining, a special, large-diameter drain hose is available from your Sundance dealer.

Once the hose is connected and the end placed where you want the water to drain, open the valve by pulling the "T" handle outward from the pipe. After draining, always remember to close the "T" handle valve *and reinstall the threaded plug* (to prevent water from seeping past the valve) prior to refilling. After refilling, turn on power to the hot tub and follow the steps listed under "Start-Up Instructions" (page 13).



### 11.3 Cleaning The Hot Tub Interior

To preserve the sheen of your hot tub's surface, it is crucial that you avoid using abrasive cleaners or cleaners which have adverse chemical effect on the surface. If you are not certain as to the suitability of a particular cleanser, consult your authorized Sundance Dealer.

Regardless of the cleanser used, use extreme care to assure that no soap residue is left on the surface. This could cause severe sudsing when the hot tub is refilled. Your Sundance Dealer offers a specially formulated surface sealant which aids in cleaning the hot tub surface and adds a protective coating to enhance the luster of the surface. This product should also be occasionally applied to the stainless steel grab rails and accents in the hot tub to help preserve their appearance.

### 11.4 Pillow Care

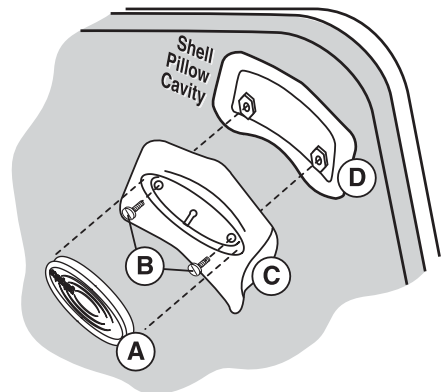
Remove and clean the headrest pillows as needed with soapy water using a cloth or soft-bristle brush. To maintain water resistance and luster, apply a quality vinyl conditioner once a month. Always remove the pillows when adding chemical shock treatment to the hot tub water. The pillows can be returned to the hot tub when the sanitizer reading drops below 5 ppm.

**IMPORTANT:** Never attempt to remove the pillows by pulling on them! The pillows utilize a bolt-on design that prohibits removal without tools.

To remove pillows:

1. Grasp center pillow insert (A) with finger tips and gently pry outward from pillow base (C).
2. Use a standard screwdriver to loosen and remove mounting bolts (B) from pillow base.
3. Assemble in reverse order after cleaning.

**DO NOT overtighten pillow mounting bolts!**



### 11.5 Maintaining The Wood Cabinet

With time and exposure to the elements, the wood on your hot tub will tend to

its new appearance. Protecting or reviving the wood surfaces is a fairly simple process. Light sanding with fine-grit sandpaper will help smooth any roughness and regular applications of a penetrating wood preservative will enhance and protect the richness of the wood. A specially formulated wood stain available from your Sundance dealer is ideal for this.

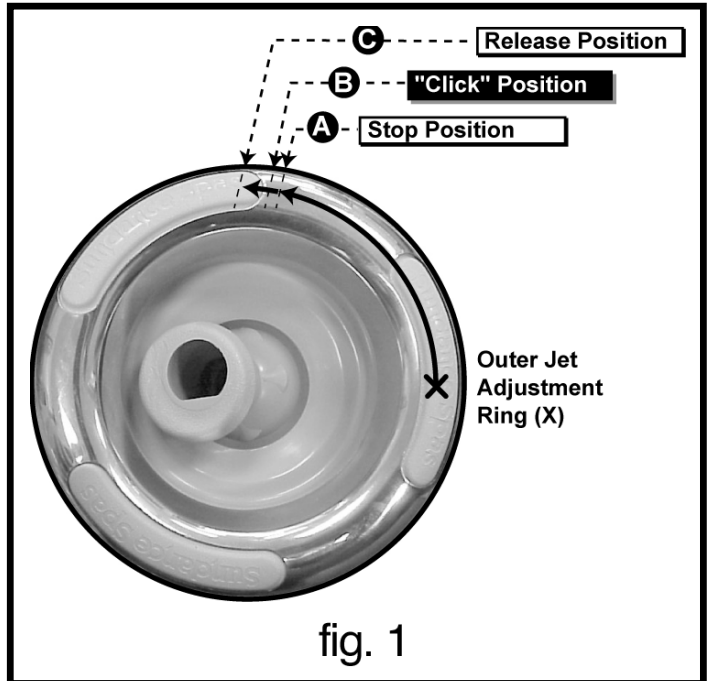
**NOTE:** Do not apply varnish, shellac or other surface sealants to the wood. These tend to react with the chemicals in the wood and the UV rays of the sun, causing yellowing, flaking and peeling.

### 11.6 Intelli-Jet Cleaning Procedure

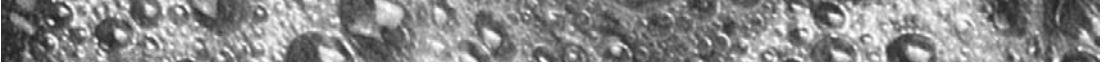
If you experience a sticky rotational jet, perform the following cleaning procedure. In most of these cases debris is present in the jet bearings and must be cleared to achieve proper operation. *Note: This procedure is considered normal maintenance for this type of jet.*

#### Procedure

1. Remove jet internal from hot tub wall fitting by placing your hand around the outer jet adjustment ring and rotating it counterclockwise (fig. 1). Rotate jet adjustment ring until it stops at position (A). Use additional force at position (A) to continue rotation until you feel a "click" at position (B); then feel the internal release at position (C). It may seem like your are overtorquing the jet internal between positions (A-B), however, additional force is necessary at position (A) to unlatch its retaining mechanism from the wall fitting.



2. Fill a clean bucket with tap water and immerse jet internal. Rotate submerged jet internal's nozzle in a circular motion while moving it back and forth allowing water to flow through both ends of the jet. This motion allows slow moving water to wash back through the jet bearing



and dislodge any debris that might be lodged in the bearing. Clean each jet internal for approximately 1 to 2 minutes twice a year, or when a particular jets rotation appears sluggish, jerky, or obstructed.

3. Reinstall jet internal by inserting it in any jet opening of the same jet type. Rotate the jet internal clockwise with light pressure until your feel the retaining mechanism “snap” in place. The jet’s nozzle should rotate freely to the left or right using only fingertip pressure. If jet rotation appears sluggish or obstructed at this time, repeat steps 2-3 until condition clears. If condition persists, contact dealer for technical support.

### 11.7 Maintaining The Cover

Using the Sundance insulating hot tub cover anytime the hot tub is not in use will significantly reduce your operating costs, heat-up time, and maintenance requirements. To prolong the life of the cover, handle it with care and clean it regularly using mild soap and water. Periodic treatments with a special conditioner developed for Sundance hot tub covers will help protect against deterioration caused by U.V. rays from the sun. Never allow anyone to stand or sit on the cover, and avoid dragging it across rough surfaces.

### 11.8 Winterizing

Your Sundance hot tub is designed to automatically protect itself against freezing when operating properly. During periods of severe freezing temperatures, you should check periodically to be certain that the electrical supply to the hot tub has not been interrupted. In extreme, bitter cold weather (less than -20°F) reset the filter cycles for 24-hour operation to protect the hot tub (i.e. four 6-hour cycles).

If you do not intend to use your hot tub, or if there is a prolonged power outage during periods of severe freezing temperatures, it is important that all water be removed from the hot tub and equipment to protect against damage from freezing.

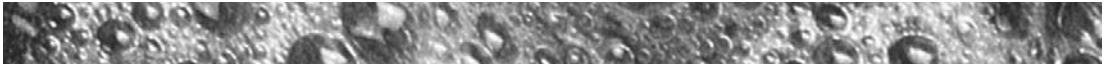
**For expert winterization of your hot tub, contact your authorized Sundance Dealer.** In emergency situations, damage can be minimized by taking the following steps:



**CAUTION: Turn off power to hot tub.**

1. Follow the directions on page 25 for draining the hot tub.
2. As the water level drops below the seats, use whatever means





necessary to get the water out of the recessed seating areas and into the footwell.

3. When the water level ceases to drop, use whatever means available to remove any remaining water from the footwell.
4. Remove the equipment-side cabinet panels and locate the drain plugs in the front of each pump (Figure-A, page 10). Remove these plugs to allow the water to drain out of the pumps and heater. (Note: Approximately one to two gallons will be released during this procedure. Use a wet/dry vacuum or other means to keep this from flooding the equipment compartment. Replace the drain plugs.
5. Loosen hose clamp at bottom of heater (Figure-A, page 10) and pull hose off of heater fitting (twist the hose back and forth while pulling downward). Tip hose down and allow to drain.
6. Re-install cabinet side panels and cover hot tub so that no casual moisture can enter into it.

Consult your Sundance Dealer if you have any questions regarding winter use or winterizing.

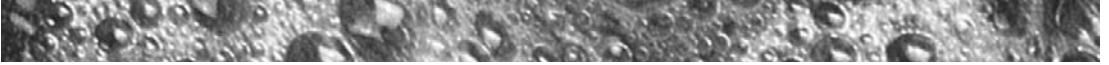
## **11.9 Restarting Your Hot Tub in Cold Weather**

If you want to start up your hot tub after it has sat empty for a time in freezing temperatures, be aware that the water remaining in certain sections of the piping may still be frozen. This situation will block water flow preventing the hot tub from operating properly and possibly damaging the equipment. We recommend you consult your dealer for guidance before attempting to restart your hot tub under these conditions.

## **12.0 Water Quality Maintenance**

Maintaining the quality of the water within specified limits will serve to enhance your enjoyment and prolong the life of the hot tub's equipment. It is a fairly simple task, but it requires regular attention because the water chemistry involved is a balance of several factors. There is no simple formula, and there is no avoiding it. A careless attitude in regard to water maintenance will result in poor and potentially unhealthful conditions for soaking and even damage to your hot tub investment. For specific guidance on maintaining water quality, consult your Authorized Sundance Dealer who can recommend appropriate chemical products for sanitizing and maintaining your hot tub.

**CAUTION:** Never store hot tub chemicals inside the hot tub's equipment bay.



## 12.1 pH Control

pH is a measure of relative acidity or alkalinity of water and is measured on a scale of 0 to 14. The midpoint of 7 is said to be neutral, above which is alkaline and below which is acidic. In hot tub water, IT IS VERY IMPORTANT TO MAINTAIN A SLIGHTLY ALKALINE CONDITION OF 7.2 to 7.8. Problems become proportionately severe the further outside of this range the water gets. A low pH will be corrosive to metals in the hot tub equipment. A high pH will cause minerals to deposit on the interior surface (scaling). In addition, the ability of the sanitation agents to keep the hot tub clean is severely affected as the pH moves beyond the ideal range. That is why almost all hot tub water test kits contain a measure for pH as well as sanitizer.

## 12.2 Sanitizing

To destroy bacteria and organic compounds in the hot tub water, a sanitizer must be used regularly. Your Sundance hot tub is equipped with the Brominator™, a special compartment built into the floating skimmer gate to hold bromine tablets. By regulating the number of bromine tablets in the Brominator™ and the length of the filtration cycles, you can control the amount of bromine which is actively working in your hot tub water. A bromine residual of 2 to 3 ppm is generally considered desirable.

A two-part bromine system or granular chlorine (Dichlor) are also acceptable sanitizers.

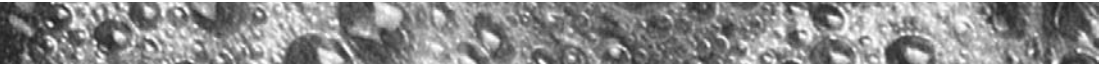
**IMPORTANT:** *Do not use chlorine tablets (Trichlor) in your hot tub. This chemical can have an extremely corrosive effect on certain materials in the hot tub. Damage caused by use of this chemical, or improper use of any chemicals, is not covered under the hot tub's warranty.*

## 12.3 Other Additives

Many other additives are available for your hot tub. Some are necessary to compensate for out-of-balance water, some aid in cosmetic water treatment and others simply alter the feel or smell of the water. Your Authorized Sundance Dealer can advise you on the use of these additives.

## 12.4 Optional SunZone™ Water Maintenance System

If you have elected to have your hot tub equipped with the optional Sundance SunZone™ UV or SunZone™ CD water purification system you will find that your water stays fresh and clear with significantly less chemical sanitizer usage. You will also probably be able to go longer between complete hot tub drainings.



## 13.0 Troubleshooting - Display Messages

There are a number of unique functions designed into your Sundance hot tub to protect it from damage and/or to aid in troubleshooting. Following is a listing of all the possible messages along with their meanings:

### MESSAGE

### MEANING

OH

Overheat Protection (Heater is deactivated, pump's low speed is activated). Water temperature is above acceptable limits. Do not enter the water! Remove hot tub cover to speed cooling. See "Water is too hot" on page 34. If condition persists, contact your dealer or authorized service center.

COOL

If the hot tub water is more than 20 °F cooler than the temperature setpoint, the low speed pump #1 and heater will automatically activate to provide freeze protection. The hot tub will stay in this mode until the water temperature reaches 15 degrees below the set temperature. No corrective action is necessary.

FLO \*

FLOW SWITCH (Heater is deactivated. Pump may also be deactivated). Proper flow of water is inhibited or a flow switch has malfunctioned. Check for proper water level and for clogged stage 2 filter (page 23). Contact your dealer or service organization.

**\* NOTE: THIS MESSAGE CAN ALSO APPEAR IF THE PUMP HAS NOT REGAINED PRIME AFTER THE HOT TUB HAS BEEN DRAINED AND REFILLED. IF YOU SUSPECT THAT THIS IS THE CASE, SEE THE INSTRUCTIONS ON PAGE 33 UNDER "PUMP DOES NOT OPERATE..."**

Hold

Panel sensors have been pressed too many times in a short period of time. Because this could cause excessive wear on equipment components, panel sensors are temporarily deactivated. Panel sensors will automatically re-activate if no sensor is pressed for 30 seconds.



**HOT**

Circuit board temperature has exceeded acceptable limit. This message will disappear when the circuit board temperature drops below acceptable limit. If condition persists, provide shade for equipment side of hot tub.

**ICE**

**FREEZE PROTECTION**

A potential freeze condition has been detected. No action is required. Pump(s) operate until the hot tub is out of danger. *Note: This error commonly occurs when the hot tub is first filled because tap water is often very cold.*

**PnL**

Communication between the control panel and/or remote control panel and circuit board is faulty. Contact your dealer or service organization.

**---**

"WATCHDOG" (hot tub is deactivated)

A problem has been detected which could cause damage to the hot tub or its components. Contact your dealer or service organization.

**Sn1**

OPEN SENSOR (heater disabled) OR

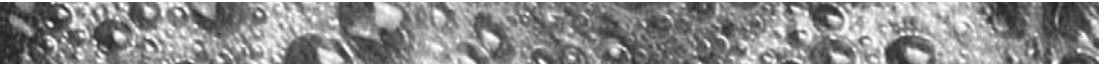
SHORTED SENSOR (hot tub is deactivated)

The high-limit temperature sensor is non-functional. This must be repaired only by a dealer or qualified service organization.

**Sn3**

OPEN OR SHORTED SENSOR (heater disabled)

The main sensor is non-functional. This must be repaired only by a dealer or qualified service organization.



## 14.0 Troubleshooting - Procedures

In the unlikely event your hot tub is not working the way you believe it should, please first review all the installation and operating instructions in this manual and check the message on the panel display; second, if you are still not satisfied it is working properly, please follow the appropriate troubleshooting instructions.

### PROBLEM

NONE OF THE COMPONENTS OPERATE (i.e. pump, light)

### PROCEDURE

Check the control panel lights.

1. If there are letters or symbols displayed on the screen, refer to the previous section to determine meaning and action required.
2. If nothing appears on the screen:
  - a. Check the household circuit breaker
  - b. Contact you dealer or authorized service center

PUMP DOES NOT OPERATE AND ICON DOES

Depress "JETS" sensor.

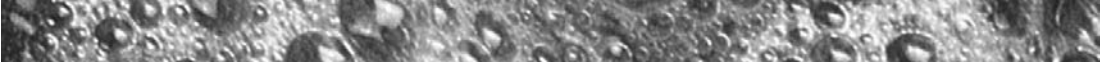
1. If no sound is detected or if a "buzzing" sound is detected, turn off power to the hot tub and contact your dealer or service center.
2. If motor operates but no water flows to jets:
  - a. Pump may not be properly primed. See instructions below
  - b. Contact dealer or authorized service center.

### **Pump Priming Instructions: *Turn Hot Tub Off!***

Remove filter and insert end of garden hose into filter pipe. Seal-off pipe opening around hose using a large, clean rag and turn on maximum water flow through the hose. After about 30 seconds, turn off water, remove hose and rag, reinstall filter and activate pump's high speed. Another method of priming the hot tub's pump(s) is as follows:

1. Turn off the power to the hot tub.
2. Remove the handle from the massage selector supplied by the pump you are priming.
3. Loosen the massage selector's cap slightly (counterclockwise), listening for the air to seep out.
4. Tighten the cap finger-tight, replace the handle and turn the hot tub's power back on.

*Note: This method must be used for pump #2 and pump #3 because these pumps are not connected to the filter.*



**IMPORTANT:** *If freezing conditions exist and pump is not operational, take measures to protect the system from freeze damage. See section titled "Winterizing", page 28.*

POOR JET ACTION  
(see Figure-F, page 16)

1. Make certain the pump is on high speed.
2. Check position of massage selectors
3. Open air control for selected jet system.
4. Check for adequate water level.
5. Check for dirty filter (page 23).
6. Check for dirty filters on all six pump #2 and pump #3 footwell suction filters (page 16).

WATER IS TOO HOT

1. Reduce thermostat setting (page 14).
2. Reduce filtration cycle length. Even with heater off, water temperature can increase from prolonged pump operation (page 21).

NO HEAT

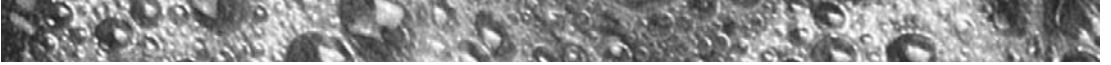
1. Check thermostat setting.
2. Keep the cover in place while heating.
3. If "heater on" indicator is lit (Figure-E, Page 15), but no temperature rise is experienced after a reasonable period of time, contact your dealer or authorized service center.

CIRCULATION PUMP  
OFF

1. Circulation pump cycle canceled by power interruption. Wait 24-hours for hot tub to reset.
2. Hot tub water is warmer than 95°F (35°C) and two degrees warmer than the set temperature. The "Summer Logic" safety feature has activated. See note on page 20 for details.

Should checking the above steps fail to correct the problem, please call your dealer so that he may arrange service.

Sundance builds the best hot tubs in the industry. Nonetheless, we are always striving to improve the quality and features of our products. Your input as a Sundance hot tub owner is a cherished part of this process. If you have any



comments or suggestions, or if you wish to be informed on any new products for your hot tub, please write to us.

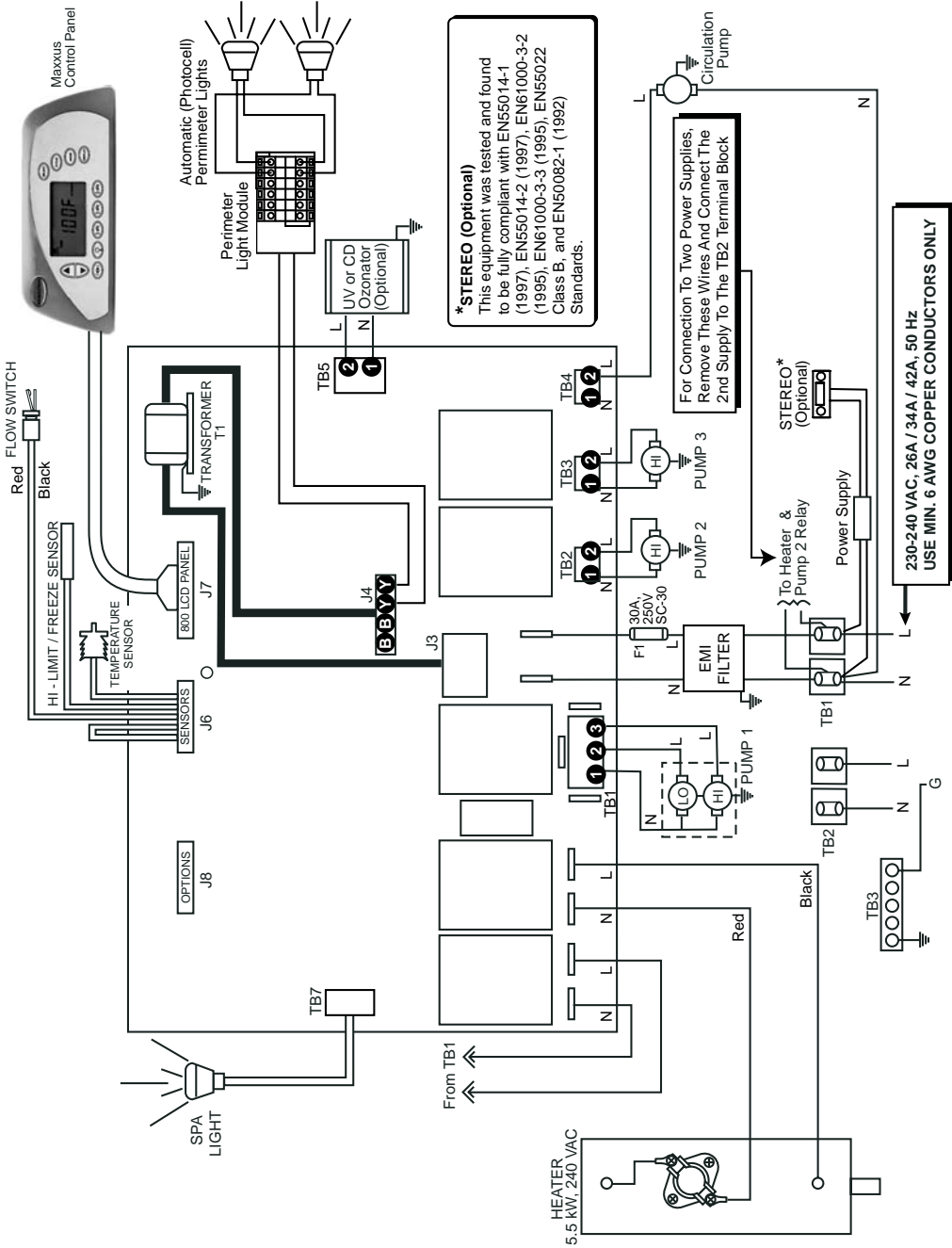
CONGRATULATIONS on your good taste and welcome to the happiest and most relaxed family in the world!





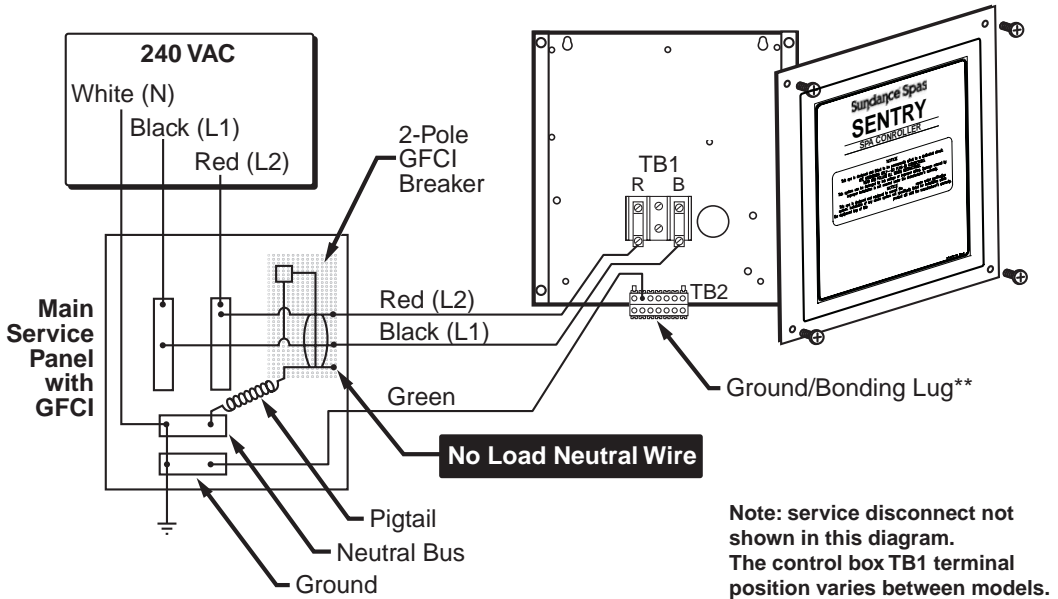


# 16.0 Electrical Wiring Diagram (Export, 230 VAC/50 Hz)

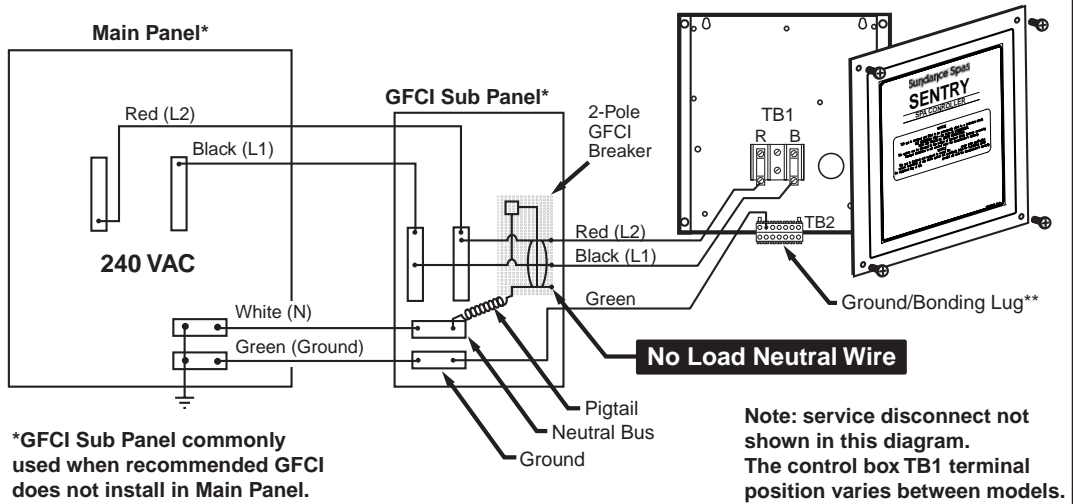


# 17.0 Typical Spa Wiring Diagrams A-B (Domestic 60 Hz Models Only)

**A** 2-Pole Circuit Breaker with 2-Wire Grounded Load Connection  
(3 Wires to Hot Tub, 2-Hot (L1-L2), 1-Ground)



**B** Main Panel with Secondary GFCI Shut-Off Box Using a 2-Pole GFCI Breaker with 2-Wire Grounded Connection  
(3 Wires to Hot Tub, 2-Hot (L1-L2), 1-Ground)





## **Sundance Spas, Inc.**

**14525 Monte Vista Ave, Chino, CA 91710/U.S.A.,**

**Phone: (909) 606-7733, Fax: (909) 606-0195**

**Website: <http://www.sundancespas.com>**